

DAYS
by
bürotime

technical document



DAYS



"Days aims to bring a new perspective to the concept of waiting in offices, while bringing the aesthetics of wooden benches, which we are accustomed to seeing as urban furniture from past to present, into indoor spaces. Each slice, with its triangular shape, forms the integral structure of the product. Slices facing the same direction line up to form part of a circle. Conversely, if each unit is positioned side by side with a one hundred and eighty degree rotation, a straight bench emerges. This unique feature adds different scenarios to seating units with different placements of a single unit.

The most striking feature of the half-back version, in addition to the full-back, is that it allows two different users to sit facing each other in a single unit. The round table, which can be positioned on both sides of the bench and provides easy access from all directions, is an aesthetic and optional addition where we can place our belongings while waiting.

Days, which can be positioned in offices, waiting areas and many other different places, modestly blends our minimal and aesthetic design touch with the past while presenting a simple function with a different language. It gently reminds users of the value of time while waiting."

Utkan Kızıltuğ

DAYS



With its design of clean lines and balanced proportions, Days brings a brand new perspective to offices and waiting areas. Its upholstery, available in a wide range of fabrics and felt options, features slices reminiscent of triangles, offering elegance and comfort in one.

The modular product range of Days can be used as a straight unit made up of individual or back-to-back benches; or it can create various combinations by combining straight and half-circle modules.



With its unique form, Days offers modern, functional and flexible solutions in waiting areas



The half-back model of Days, which has full and half-back options, provides users with a more personal and comfortable space by allowing them to sit in different directions on the same bench.



The optional electric solution ensures that electronic devices can be easily charged, while the table option that can be added to the edges of the bench or the junction points of the modules creates spaces where personal items can be placed while waiting.

product family

waiting unit



linear waiting unit



C waiting unit



back module



half back module



C back module

coffee table



round coffee table - L connection



round coffee table - T connection

connection module



connection part



blue socket connection part

size chart

waiting unit

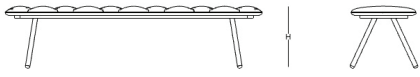

W: 46 - L: 183 - H: 44



W: 105 - L: 191 - H: 44

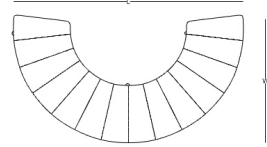
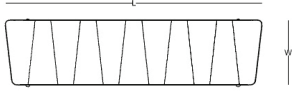

linear waiting unit

C waiting unit

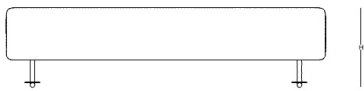

W: 20 - L: 168 - H: 40

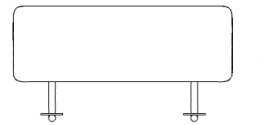

W: 20 - L: 79 - H: 40

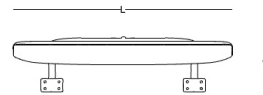

back module

half back module

W: 50 - L: 93 - H: 40

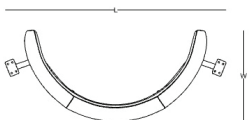
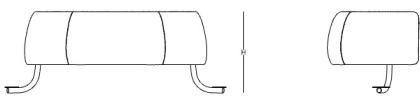

W: 46 - L: 32 - H: 22

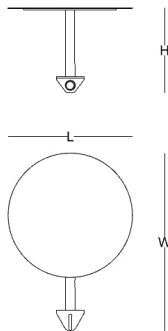

round coffee table - L connection

W: 61 - L: 32 - H: 22

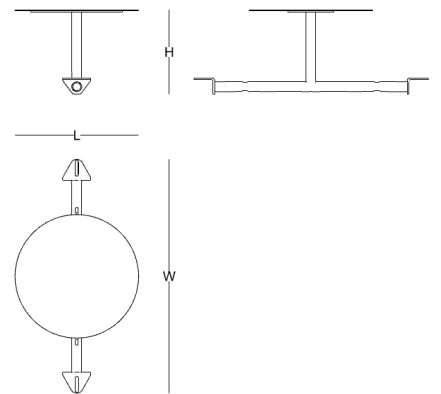

round coffee table - T connection

C waiting unit

color options

fedora

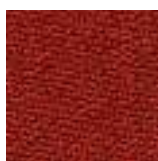

FDR 101
red

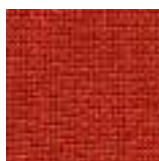

FDR 102
orange

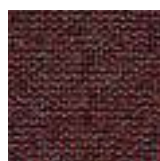

FDR 403
cosmic



FDR 202
amber

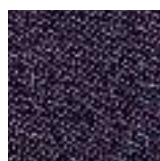

FDR 203
purple



FDR 301
rosa



FDR 302
salmon



FDR 303
lilac



FDR 104
blue

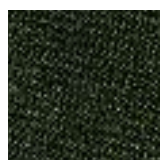

FDR 205
mass

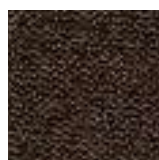

FDR 106
brown



FDR 204
atlantic



FDR 105
green

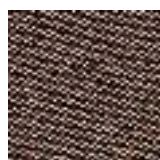

FDR 306
mink

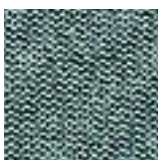

FDR 304
river

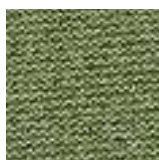

FDR 305
thyme



FDR 107
beige



FDR 310
grey

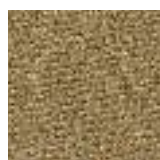

FDR 108
wheat



FDR 109
yellow



FDR 208
star dust



FDR 210
graphite



FDR 110
black

The color and texture on our website, printed and digital technical product documentation, may vary depending on the screen resolution settings and photo quality. True colors, you can visit our closest lady and see from our color cartel.

color options

felt



W 102
coral

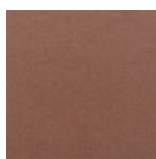

W 202
brown



W 203
green



W 104
grey

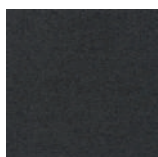

W 105
anthracite



W 106
black

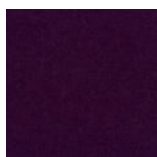

W 207
purple

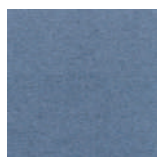

W 205
dark blue

camira synergy



LDS74
coral



LDS73
light salmon

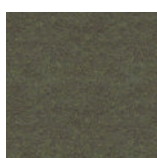

LDS48
olive green



LDS47
grass green

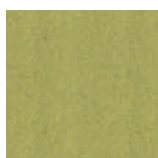

LDS46
lime green

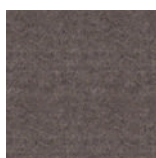

LDS33
mink



LDS83
light orange

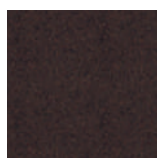

LDS39
dark brown

metal



white

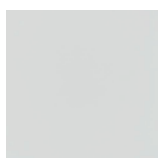

grey



sand

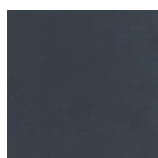

anthracite



blue



brick

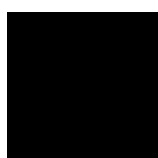

black



green

The color and texture on our website, printed and digital technical product documentation, may vary depending on the screen resolution settings and photo quality. True colors, you can visit our closest lady and see from our color cartel.